

# HC10 Series Intelligent Controller

## Installation and User Manual



Warning

- Be sure to check the terminal label carefully when wiring.
- Avoid installation in places exposed to direct sunlight, moisture, or water.
- Avoid installation in locations with flammable and explosive gases and liquids.
- Avoid installation in areas with oily dust, fibers and metal particles.
- Use rails or M3 screws for installation.

### Model Definition

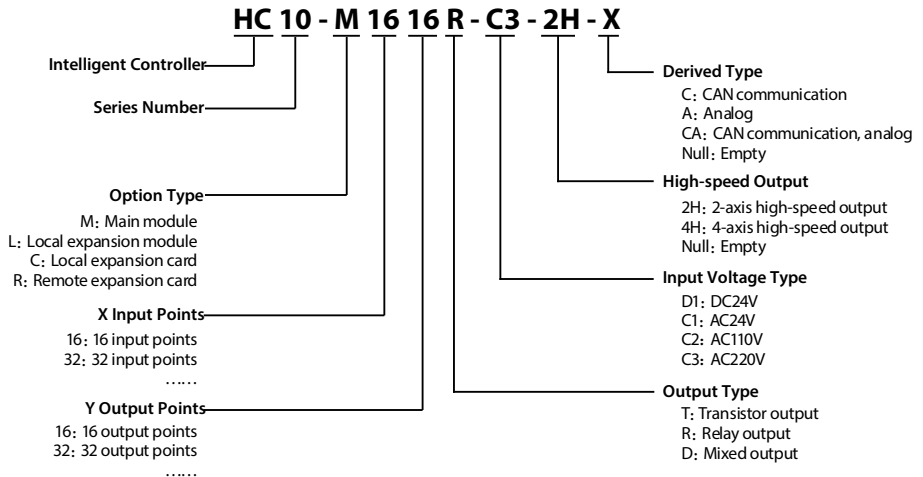

### Dimensions Size (mm)

HC10-M0808R-C3 (gross weight: 0.37kg)

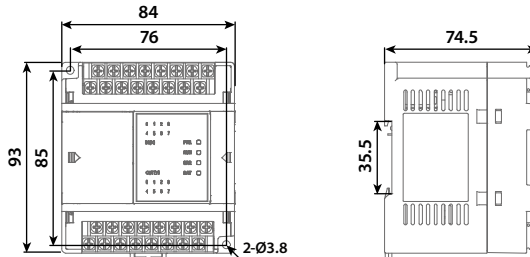

HC10-M1616R-C3-CA (gross weight: 0.54kg)

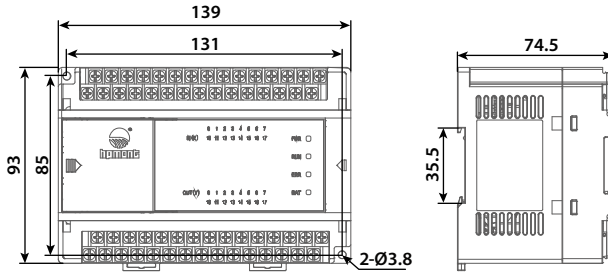

HC10-M3232R-C3 (gross weight: 0.85kg)

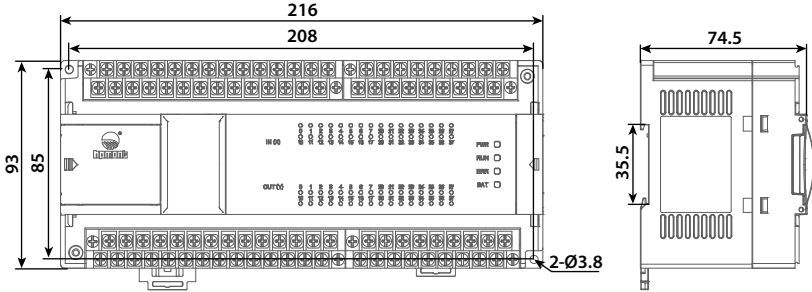

## Structure Description

HC10-M0808R-C3

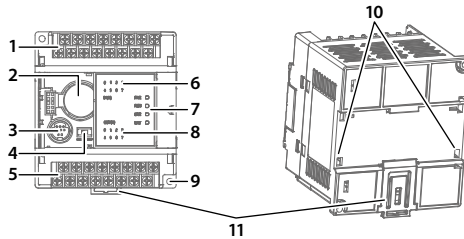

HC10-M1616R-C3-CA

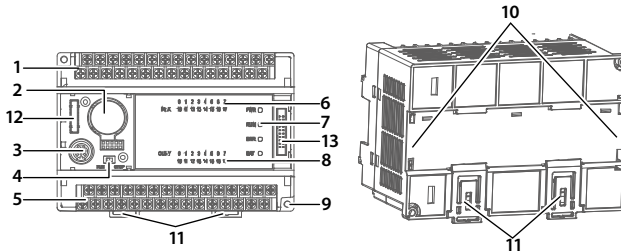

### HC10-M3232R-C3

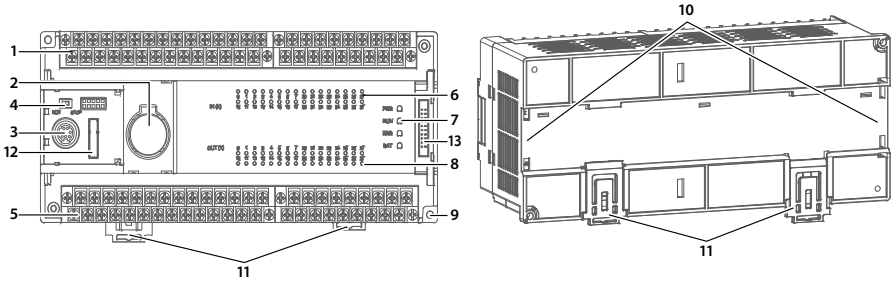

1/5	Input/output terminal	9	Mounting fixing hole (M3)
2	Battery	10	DIN guideway groove (35mm)
3	Programming interface	11	DIN rail fixing buckle
4	Run/stop	12	Local expansion card installation location
6/8	Input/output indicator	13	Expansion module access interface
7	Power/run/fault/battery indicator LED		

### Terminal Description

#### HC10-M0808R-C3

N	⊖	0V	X0	X2	X4	X6	.		
L	.	24V	S/S	X1	X3	X5	X7		
		Y1	Y3	COM1	Y5	Y7	.	MOD1+	MOD2+
Y0	Y2	COM0	Y4	Y6	.	MOD1-	MOD2-		

#### HC10-M1616R-C3-CA

N	⊖	0V	X0	X2	X4	X6	X10	X12	X14	X16	.	V12	V-	V02		
L	.	24V	S/S	X1	X3	X5	X7	X11	X13	X15	X17	V11	V-	V01		
		Y1	COM1	Y3	Y5	Y7	COM3	Y11	Y13	Y15	Y17	.	24V	MOD1+	MOD2+	CAN+
Y0	COM0	Y2	Y4	Y6	COM2	Y10	Y12	Y14	Y16	.	0V	MOD1-	MOD2-	CAN-		

#### HC10-M3232R-C3

N	⊖	0V	X0	X2	X4	X6	X10	X12	X14	X16	X20	X22	X24	X26	X30	X32	X34	X36	.	.	.	.		
L	.	24V	S/S	X1	X3	X5	X7	X11	X13	X15	X17	X21	X23	X25	X27	X31	X33	X35	X37	.	.	.	.	
		Y1	COM1	Y3	Y5	Y7	COM3	Y11	Y13	Y15	Y17	COM4	Y21	Y23	Y25	Y27	COM5	Y31	Y33	Y35	Y37	.	MOD1+	MOD2+
Y0	COM0	Y2	Y4	Y6	COM2	Y10	Y12	Y14	Y16	.	Y20	Y22	Y24	Y26	.	Y30	Y32	Y34	Y36	.	MOD1-	MOD2-		

HC10-M0808R-C3			
Terminal	Description	Terminal	Description
X0 ~ X1, S/S	Ordinary digital/high speed pulse input	24V, 0V	+24V power supply
X2 ~ X7, S/S	Ordinary digital input	L, N	Power input, 100 ~ 240VAC
Y0 ~ Y3, COM0	Relay output	MOD1+/MOD1-	RS485 communication interface
Y4 ~ Y7, COM1		MOD2+/MOD2-	RS485 communication interface

HC10-M1616R-C3-CA			
Terminal	Description	Terminal	Description
X0 ~ X3, S/S	Ordinary digital/high speed pulse input	V11 ~ V12, V-	Analog input
X4 ~ X7, S/S	Ordinary digital input	VO1 ~ VO2, V-	Analog output
X10 ~ X17, S/S		24V, 0V	+24V power supply
Y0 ~ Y1, COM0	Relay output	L, N	Power input, 100 ~ 240VAC
Y2 ~ Y3, COM1		MOD1+/MOD1-	RS485 communication interface 1
Y4 ~ Y7, COM2		MOD2+/MOD2-	RS485 communication interface 2
Y10 ~ Y17, COM3		CAN+/CAN-	CAN communication interface

HC10-M3232R-C3			
Terminal	Description	Terminal	Description
X0 ~ X3, S/S	Ordinary digital/high speed pulse input	24V, 0V	+24V power supply
X4 ~ X7, S/S	Ordinary digital input	L, N	Power input, 100 ~ 240VAC
X10 ~ X17, S/S		MOD1+/MOD1-	RS485 communication interface 1
X20 ~ X27, S/S		MOD2+/MOD2-	RS485 communication interface 1
X30 ~ X37, S/S			
Y0 ~ Y1, COM0	Relay output		
Y2 ~ Y3, COM1			
Y4 ~ Y7, COM2			
Y10 ~ Y17, COM3			
Y20 ~ Y27, COM4			
Y30 ~ Y37, COM5			

## Product Specifications

General Specifications	
Environmental temperature	Run: -10 ~ +55°C; Storage: -40 ~ +70°C
Relative humidity	<95%, no condensation
Altitude	Run: <2000m; Storage: 0 ~ 3000m (not less than 70kPa)
Pollution level	Pollution level 2
Withstand voltage	1,500VAC (primary side (P1) -ALL), 1,500VAC (secondary side (P2) -ALL), 500VDC (ELV -ALL)
Electromagnetic compatibility	ESD: 8kV air discharge; EFT: Power line (2kV), I/O (1kV), analog (1kV)
Ground	Third grounding (cannot be grounded in common with high voltage systems)

Power Specifications	
Power supply voltage	100 ~ 240VAC (-10 ~ +10%), 50/60Hz
Action specification	When the power supply rises to 90 ~ 100VAC, the intelligent controller starts to operate When the power supply drops to 88VAC, the intelligent controller stops
Allow instant power outage	The power supply will continue to run within the instantaneous power outage 10ms
Power fuse capacity	3.15A/250VAC
Electric shock	≤12A
Power consumption	30VA
DC24V current output	200mA
Power protection	DC24V output has short circuit protection
Note	<ol style="list-style-type: none"> <li>1. The power cable needs to be larger than 2mm<sup>2</sup> to prevent voltage drop.</li> <li>2. Avoid access to high-voltage, high-current power supplies or cables.</li> <li>3. Do not overvoltage the power supply, polarity is correct.</li> </ol>

Digital Input Specification		
Points	HC10-M0808R-C3: 8 (X0 ~ X7), HC10-M1616R-C3-CA: 16 (X0 ~ X7, X10 ~ X17) HC10-M3232R-C3: 32 (X0 ~ X7, X10 ~ X17, X20 ~ X27, X30 ~ X37)	
Connection	Barrier terminal block (end point distance: 7.62mm)	
Signal form	Contact input or source (drain) mode	
Circuit insulation	Photoelectrical coupling insulation	
Action display	LED light goes on with system's operation, LED light goes out when system is shut-down	
Voltage range	15 ~ 30VDC	
Common	A common end S/S	
Point type	High speed pulse	Ordinary digital
Current	ON: Greater than 7.5mA (>15V)	ON: Greater than 3.5mA (>15V)
	OFF: Less than 2.5mA (<5V)	ON: Less than 1.2mA (<5V)
Resistance	3.3kΩ	4.7kΩ
Hardware filtering time	/	About 200us
Support pulse	≤100kHz	≤1kHz

Digital Output Specification			
Points	HC10-M0808R-C3: 8 (Y0 ~ Y7), HC10-M1616R-C3-CA: 16 (Y0 ~ Y7, Y10 ~ Y17) HC10-M3232R-C3: 32 (Y0 ~ Y7, Y10 ~ Y17, Y20 ~ Y27, Y30 ~ Y37)		
Connection	Barrier terminal block (end point distance: 7.62mm)		
Circuit insulation	Optocoupler insulation		
Action display	LED light goes on with system's operation, LED light goes out when system is shut-down		
Common	Two groups, four groups or eight groups have a common terminal, the group is isolated from the group		
Point type	High speed pulse	Ordinary transistor	Relay
Response time	/	ON-OFF: <0.2ms	ON-OFF: <5ms
Support frequency	≤100kHz	≤1kHz	/
External voltage	5 ~ 30VDC		250VAC, below 30VDC
Maximum load	Resistive	50mA/1 point	3A/1 point (5A/COM)
	Inductive	1.2W (24VDC)	80VA
	Light bulb	0.2W (24VDC)	20W (DC)/100W (AC)

Analog Input Specification (HC10-M1616R-C3-CA)		
Points	2 (VI1, VI2)	
Connection	Barrier terminal block (end point distance: 7.62mm)	
Form	Voltage or current optional	
Negative common	V-	
Range	Voltage: 0 ~ 10V	Current: 0 ~ 20mA
Resistance	Voltage: 31k $\Omega$	Current: 500 $\Omega$
Resolution	10mV	10 $\mu$ A
Array input	0 ~ 32000	0 ~ 32000
Comprehensive accuracy	$\pm$ 3% full range	

Analog Output Specification (HC10-M1616R-C3-CA)		
Points	2 (VO1, VO2)	
Connection	Barrier terminal block (end point distance: 7.62mm)	
Form	Voltage or current optional	
Negative common	V-	
Range	Voltage: 0 ~ 10V	Current: 0 ~ 20mA
Load	Voltage: 2k $\Omega$ ~ 1M $\Omega$	Current: 0 ~ 500 $\Omega$
Resolution	10mV	10 $\mu$ A
Array output	0 ~ 32000	0 ~ 32000
Comprehensive accuracy	$\pm$ 3% full range	

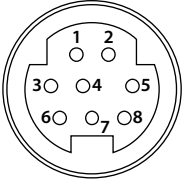
Communication Interface (HC10-M0808R-C3/HC10-M3232R-C3)		
RS485 communication interface	MOD1+/MOD2+ (485+), MOD1-/MOD2- (485-)	
RS422 communication interface	1: RXD- 2: RXD+ 3: GND 4: TXD- 5: VCC 7: TXD+	

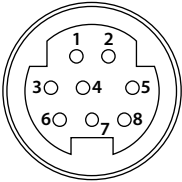
Communication Interface (HC10-M1616R-C3-CA)		
RS485 communication interface	MOD1+/MOD2+ (485+), MOD1-/MOD2- (485-)	
RS422 communication interface	1: RXD- 2: RXD+ 3: GND 4: TXD- 5: VCC 7: TXD+	
CAN communication interface	CAN+/CAN-	

# Instructions

## (1) Digital Input Wiring

Relay Form

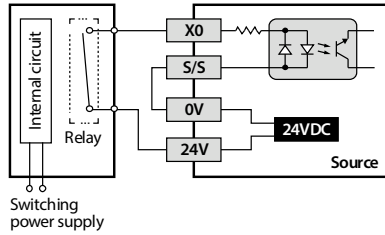
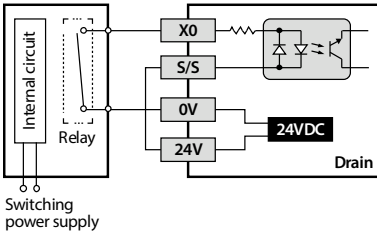

Open-circuit Collect Form

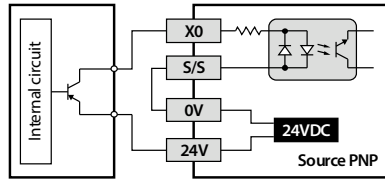
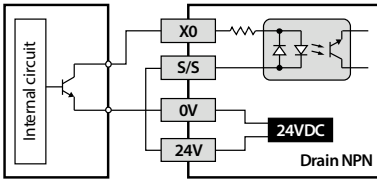

2-wire Proximity Switch

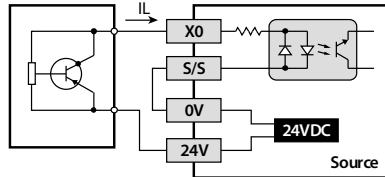
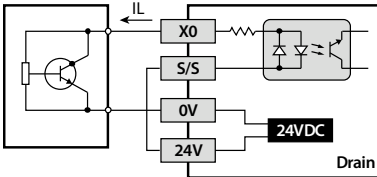

## (2) Digital Output Wiring

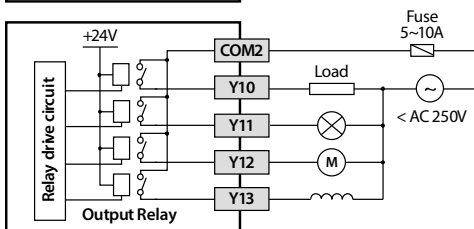
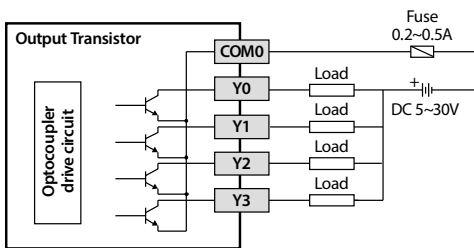

**Note:**  
In order to prevent the load from short-circuiting and other blows to burn out the output unit, please select the fuse for each load.

### (3) Analog Input Wiring

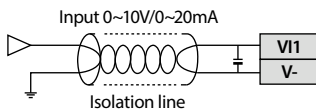

- 1: Please isolate the analog input from other power cables.
- 2: If the analog input is disturbed by noise, the 0.1 ~ 0.47 $\mu$ F 25V capacitor or ferrite ring can be connected.
- 3: Before the current input, change the address corresponding to analog input to current input.

### (4) Analog Output Wiring

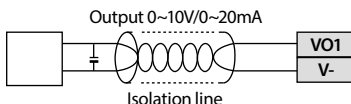

- 1: Please isolate the analog output from other power cables.
- 2: If the analog output is disturbed by noise, the 0.1 ~ 0.47 $\mu$ F 25V capacitor or ferrite ring can be connected.
- 3: Before the current output, the analog output must be corresponding to the jumper 2/3 pin short connection.

### (5) Analog Input and Output Usage Method

Analog Input and Output Related Software Special Address					
Category	Terminal	Address	Voltage and Current Selection (ON/OFF)	Gain	Bias
Analog input	V1	D8256	M8256	D8220	D8221
	V12	D8257	M8257	D8222	D8223
Analog output	VO1	D8258	M8258	D8224	D8225
	VO2	D8259	M8259	D8226	D8227

- 1: The analog can modify the range of the actual output address (D8256 ~ D8257) through modifying the range (1 ~ 32767) and offsetting special address (-32768 ~ +32767). Such as:  
When AI1 is a voltage type, set the range D8220 as 1000 and D8221 as 2000, then after the change, AI1 input 0 ~ 10V corresponds to D8256 output 2000 ~ 3000.
- 2: The default range is 32000, and the offset is 0, that is, the default range of the analog input value and the analog output value is 0 ~ 32000.
- 3: When the set value of the analog output is lower than the lower limit, press the lower limit output; When higher than the upper limit, output according to the upper limit.